



**Your expert for  
catalyst support material,  
tower packings and  
column internals.**

*Ihr Spezialist für  
Inert-Kugeln, Füllkörper und Kolonneneinbauten.*

**CATALYST SUPPORT  
KATALYSATORTRÄGER**

**1 DURANIT® inert balls  
DURANIT® Inert Kugeln**



**2 Covering layers for catalyst beds  
Katalysatorabdeckungen**

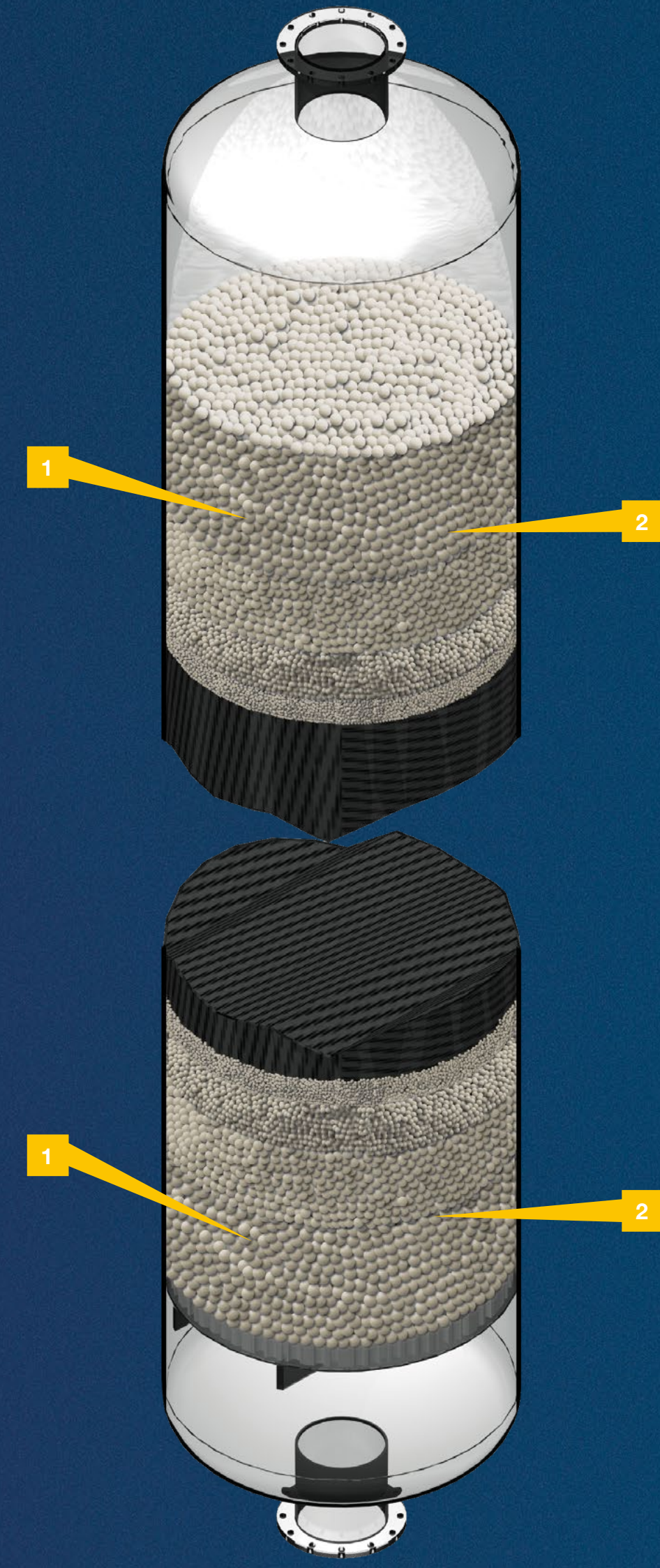

**COLUMN INTERNALS  
KOLONNENEINBAUTEN**

**3 droplet separators / demisters  
Tropfenabscheider / Demister**



**6 liquid distributors / collectors  
Flüssigkeitsverteiler / -sammler**

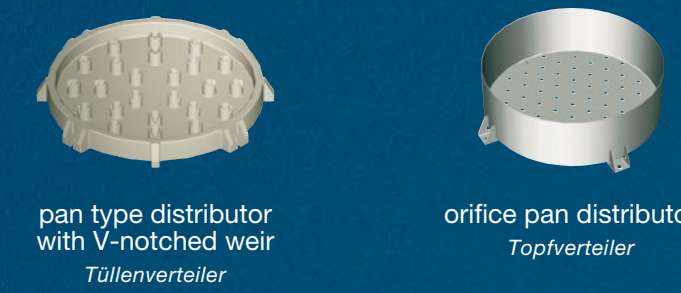

**4 support plates / grids  
Auflageböden / Roste**



**6 liquid distributors / collectors (continued)**

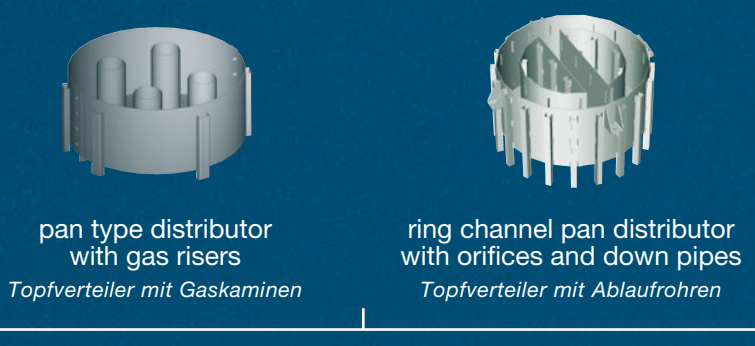

**6 liquid distributors / collectors (continued)**

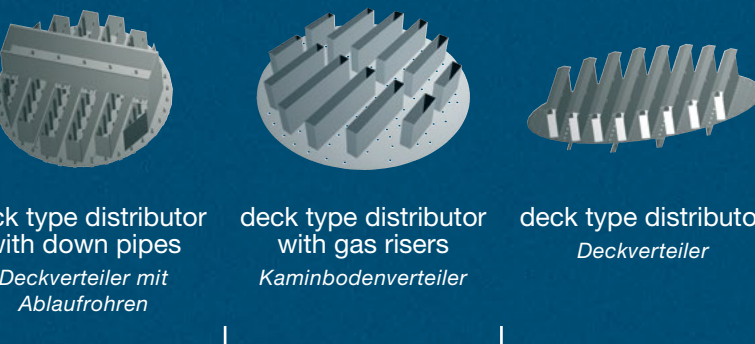

**6 liquid distributors / collectors (continued)**

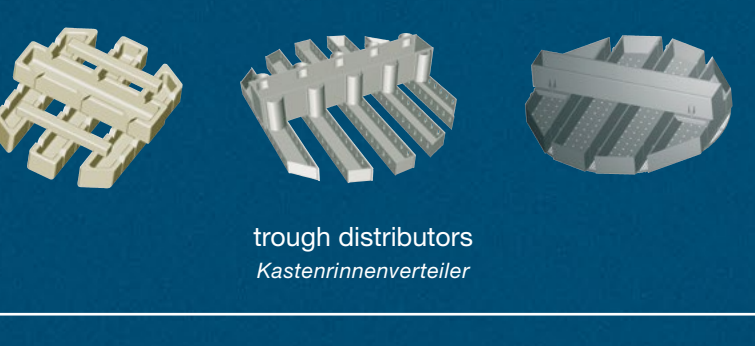

**6 liquid distributors / collectors (continued)**

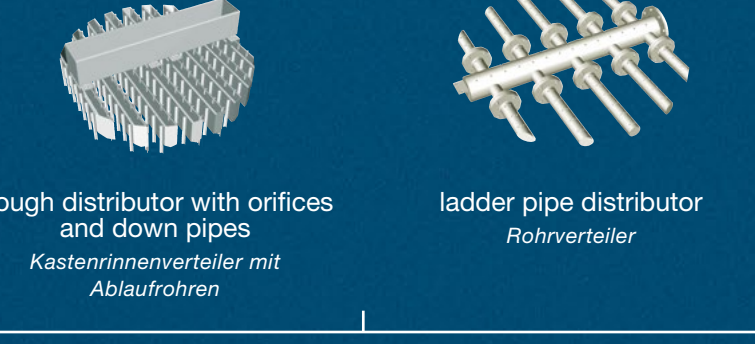

**5 feed devices: gas / liquids  
Zulaufrohre; Gas / Flüssigkeiten**

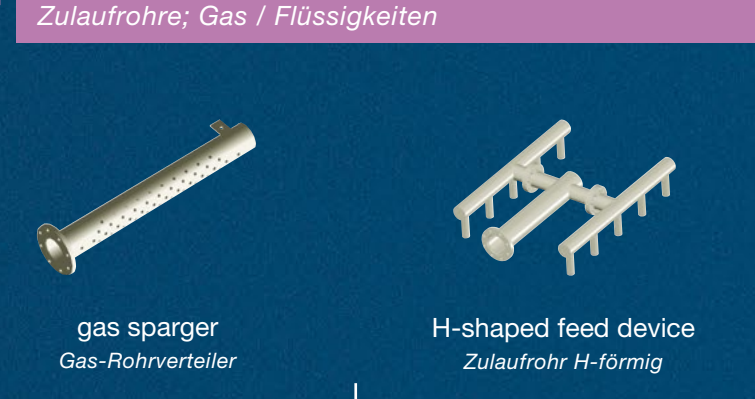

**6 liquid distributors / collectors (continued)**



**TOWER PACKINGS  
FÜLLKÖRPER**

**7 random packings made of plastic  
Füllkörper aus Plastik**



**10 random packings made of ceramic  
Füllkörper aus Keramik**

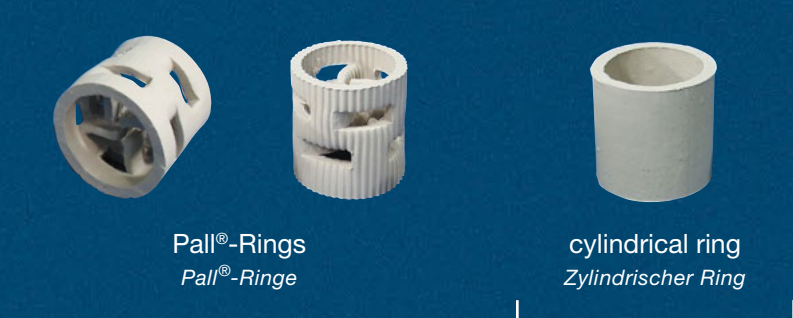

**7 random packings made of plastic (continued)**



**10 random packings made of ceramic (continued)**

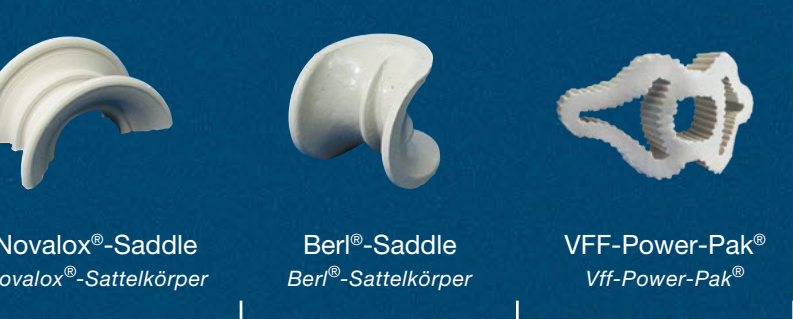

**8 random packings made of metal  
Füllkörper aus Metall**

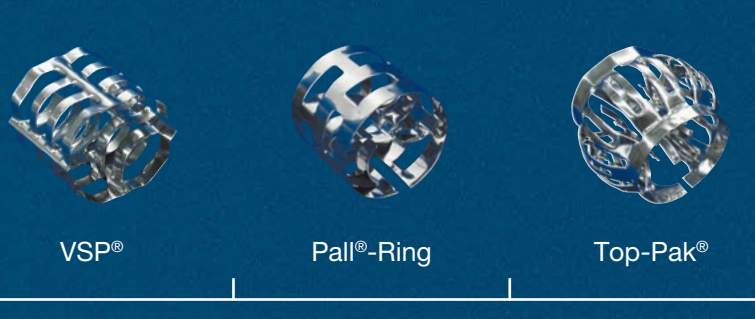

**10 random packings made of ceramic (continued)**



**8 random packings made of metal (continued)**

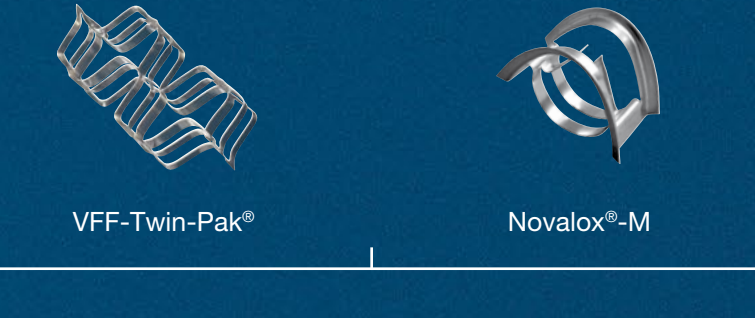

**10 random packings made of ceramic (continued)**



**8 random packings made of metal (continued)**

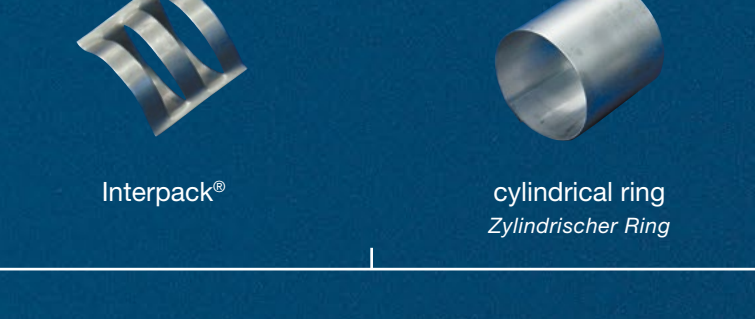

**10 random packings made of ceramic (continued)**



**9 random laboratory packings  
Laborfüllkörper**



random laboratory packings made of ceramic and porous ceramic, metal, wire netting, glass or carbon  
Laborfüllkörper aus Keramik und poröser Keramik, Metall, Maschendraht, Glas oder Kohlenstoff

